

XIaomi Smart Air Fryer 4,5 | User Manual



Read this manual carefully before use, and retain it for future reference.

Thank you for choosing Xiaomi Smart Air Fryer 4.5L. This product is for household use only. Illustrations of product, accessories, and user interface in the user manual are for reference purposes only. Actual product and functions may vary due to product enhancements.

Safety Instructions

- This appliance can be used by children aged from 8 years and above and persons with reduced physical, sensory or mental capabilities or lack of experience and knowledge if they have been given supervision or instruction concerning use of the appliance in a safe way and understand the hazards involved. Children shall not play with the appliance. Cleaning and user maintenance shall not be made by children unless they are older than 8 and supervised.
- Please keep the air fryer and the power cord out of the reach of children aged under 8.
- For household use only.
- If the power cord is damaged or broken, it must be replaced by the manufacturer or after-sales service department to avoid safety hazards.
- The temperature of the accessible surface may rise while the air fryer is working.
- The surface will heat up easily while the air fryer is in use.
- The air fryer should not be operated via an external timer or a separate remote control.
- Do not block the air fryer's air inlet and outlet, nor the heat dissipation vents during use to avoid affecting its normal heat dissipation.
- Any non-professionally trained technicians should not modify the internal wiring of the air fryer.
- Do not use charcoal or other similar fuel sources to heat the basket, frying plate, or grill.
- Do not place the basket on any other heat sources, such as an induction cooker or gas stove.
- Do not plug or unplug the power cord with wet hands to avoid the risk of an electrical shock.
- Do not use a power cord with loose connection or poor contact.
- Do not let the power cord cross through sharp objects to avoid damage to the power cord.

- Do not use the air fryer to store any items, especially flammable, explosive, or corrosive items.
- Do not excessively pinch, bend, twist, or place heavy objects on the power cord to prevent from exposing or breaking its core.
- Stop using the air fryer immediately and unplug it from the power source if it doesn't function normally or malfunctions.
- The air fryer cannot be started without the basket being in place.
- Do not touch the basket directly with your hands during or right after use to avoid getting scalded.
- Do not allow children to get close to or play with the cling wrap and packaging to avoid suffocation accidents.
- Do not use any plastic utensils or normal paper wrapping materials to wrap food for cooking.
- Do not drop this air fryer or bump it against hard objects to avoid damage or malfunction.
- Do not insert pins, wires or other objects into any of the openings of the air fryer to avoid an electrical shock or injury.
- Do not use any accessories that are not recommended by the manufacturer.
- The normal operating altitude range of this product is 0–2000 meters.
- Keep a distance of 30 cm or more between the air outlet and other devices during use.
- Do not move or shake the air fryer during use.
- Do not insert any foreign objects into the safety switch to avoid causing any danger.
- When placing the air fryer in a kitchen cabinet, etc., please ensure that it is well ventilated.
- Please be sure to unplug the air fryer before cleaning or repairing it.
- This product must be used on a level, heat-resistant surface to avoid damage to the product or accidents.
- Ensure that the silicone parts of the air fryer do not come into contact with ethanol or solutions that contain more than 50% of alcohol.
- Please ensure that the electrical outlet the air fryer is plugged into is well grounded to avoid an electrical shock or other safety hazards.

- Only use a grounded electrical outlet with a rated current of 10 A to avoid the risk of fire and other potential hazards.



CAUTION: Hot surfaces.

Product Overview

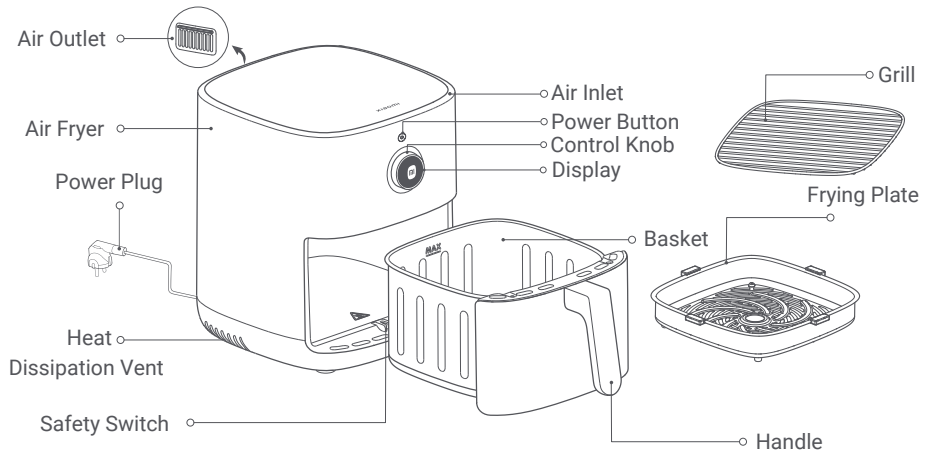

- Notes: 1. The silicone rubber on the frying plate is made of high temperature resistant food-grade materials to prevent the edges of the frying plate from scratching the coating of the basket and to improve the stability of the frying plate. Do not remove the silicone rubber from the frying plate.
2. Ingredients that are too small are not suitable for use on the grill. Please make sure that ingredients don't fall through the gaps in the grill.

Control Knob



- 1 Press the power button to turn on/off.



- 2 Press to confirm selection.



- 3 Press and hold for 1 second to return to the previous menu.

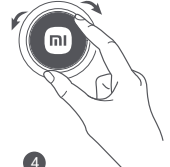

- 4 Turn left/right to change functions.

How to Use

Connect the power cord and press the power button to turn on the air fryer.

- Notes: 1. When the air fryer is turned on for the first time, press the power button and go to the language selection screen, turn the control knob to the desired language, then press the control knob to confirm the selection.
2. The air fryer may give off a minor odor on first use. It is recommended to run the air fryer with an empty basket at the maximum temperature (200°C) for 5 minutes to remove the odor. The air fryer may emit a small amount of white smoke or an odor while running with an empty basket, which is normal.

Turning on

Connect the power cord and press the power button to turn on the air fryer.

Turning off

Press the power button to turn off the air fryer, regardless of the state it is in.



Setting Wi-Fi





- Resetting Wi-Fi:

Press the control knob to enter "Reset Wi-Fi" while in the "Wi-Fi" screen, then press the control knob to select Yes to reset the Wi-Fi, or turn the control knob to select No to abandon resetting the Wi-Fi.

- Enabling/disabling Wi-Fi:

Press the control knob to enter "Enable/Disable Wi-Fi" while in the "Wi-Fi" screen, then press the control knob to select Yes to enable or disable the Wi-Fi, or turn the control knob to select No to abandon the change.

Wi-Fi status indicator

			
Awaiting fast connection...	Reconnecting after a disconnection...	Connected successfully	Updating...
Wi-Fi indicator blinks slowly	Wi-Fi indicator blinks quickly	Wi-Fi indicator stays on	Wi-Fi indicator blinks quickly

Note: If the air fryer does not connect to the Wi-Fi for 30 minutes, the Wi-Fi indicator will turn off.

Updating firmware

During a firmware update via the Mi Home/Xiaomi Home app, the display shows that an update is in progress. Upon completion of the update, the air fryer will restart automatically.

Note: The Mi Home/Xiaomi Home app will be able to update the firmware unless the air fryer or its display is turned off, or the Wi-Fi is disconnected. Other operations cannot be performed when the firmware update is in progress.

Connecting with the Mi Home/Xiaomi Home app

This product works with the Mi Home/Xiaomi Home app*. Control your device with Mi Home/Xiaomi Home app.



- Scan the QR code to download and install the app. You will be directed to the connection setup page if the app is installed already. Or search for "Mi Home/Xiaomi Home" in the app store to download and install it.
- Open the Mi Home/Xiaomi Home app, tap "+" on the upper right, and then follow the instructions to add your device.

* The app is referred to as Xiaomi Home app in Europe (except for Russia). The name of the app displayed on your device should be taken as the default.

Note: The version of the app might have been updated, please follow the instructions based on the current app version.

Cooking

Preparations

The ingredients can be marinated to taste before cooking.

Note: Do not cook foods containing baking soda (sodium hydroxide), such as pretzel buns, to prevent damage to the air fryer's coating.

Start cooking

1. Place the air fryer on a stable, level surface and ensure that there is air circulation around the air fryer.

2. Place the frying plate at the bottom of the air fryer and put the prepared food onto the plate. Avoid overfilling or piling the food beyond the frying plate's rim. This will ensure the best cooking results without the need to turn over the food.

Notes: 1. Overstuffing the air fryer with ingredients might interfere with the hot air flow inside it, which could prevent the food from heating evenly. It may be necessary to adjust the cooking time and turn over the food to achieve the ideal cooking effect.
2. If there are more ingredients, use the grill to place them in layers.

3. When the basket is completely pushed into the air fryer, turn the control knob to select the appropriate recipe and set the parameters (such as the amount of ingredients, mode, cooking temperature, and cooking time) accordingly. Then press the control knob to confirm settings and start cooking.

Notes:

1. The cooking time and temperature (except for yogurt) can be adjusted during the cooking process without needing to pause. After making the adjustments, press the control knob to confirm the new settings, and the cooking will continue based on these updated parameters.

2. Neither the recipe nor the mode can be switched while cooking is underway.

4. When the air fryer's basket is pulled out during cooking, the countdown will blink and cooking will pause. Parameter adjustments are not allowed in this state. Placing the basket back allows the cooking timer to resume, and cooking continues.

Note: For cooking no less than 400 g of fries, a prompt to flip the ingredients halfway through will be provided.

5. Once the cooking countdown ends, the air fryer will give off a long beep to indicate the completion of cooking. Carefully take out the basket and use tongs to remove the food.

CAUTIONS: 1. When cooking is completed, the basket is very hot, so do not touch it to avoid getting scalded.

2. If the keep-warm feature is enabled at the end of cooking, the air fryer will automatically transition to the keep-warm mode.

Other Operations

1. Language settings

- Turn on the air fryer, go to settings, and press the control knob to enter the language selection screen.
- Turn the control knob to the desired language and press it to confirm.

2. Manual mode

- When the air fryer is turned on, press the control knob to enter the manual mode, then turn the control knob to the desired cooking temperature, press the control knob to set the time and turn the control knob to the desired cooking time, and finally press the control knob to start the manual cooking program.

3. Temperature/time adjustment

- The temperature can be adjusted between 40°C and 200°C. The time can be adjusted between 0–24 hours.
- The cooking temperature is adjusted by 5°C for each turn of the control knob.
- When adjusting or modifying the time parameters in the recipe cooking mode, if the cooking temperature is between 80°C and 200°C, the adjustable cooking time is ≤ 1 hour; if the cooking temperature is $< 80^\circ\text{C}$, the adjustable cooking time is ≤ 24 hours.
- When adjusting the cooking time or scheduled completion time, pay attention to the speed at which the control knob is turned. When the adjusted time range is ≥ 60 minutes, turning the control knob quickly will adjust the time by 60 minutes, while turning the control knob slowly will adjust the time by 1 minute. When the adjusted time range is < 60 minutes, turning the control knob quickly will adjust the time by 10 minutes, while turning the control knob slowly will adjust the time by 1 minute.

4. Scheduled cooking

- Press the control knob to select the schedule function, turn the control knob to select the scheduled recipe, then set the cooking temperature/time and scheduled completion time. The air fryer will automatically start cooking at a proper time to ensure that the cooking is completed within the scheduled time, and then enter the keep-warm state or finish cooking once done.

Notes:

1. The scheduled time must be longer than the cooking time, but less than 24 hours.
2. The scheduled time refers to the total time period within which the cooking process is expected to be completed. For instance, if the display reads "02:40", it indicates that the cooking will be completed within 2 hours and 40 minutes.
3. The schedule function is not supported in yogurt, dried fruit, and defrost modes.

5. Keep-warm function

- The keep-warm function is enabled by default. This function can be enabled or disabled by navigating to settings > thermostat settings and pressing the control knob on the display. A press-and-hold action on the display for 1 second is required to disable the keep-warm mode once it is enabled.
- The keep-warm function is set to last for 30 minutes at a temperature of 80°C. If the air fryer's basket is pulled out while this function is enabled, both the function and its timer will pause instantly. If the air fryer is placed back within 1 minute, the function and its timer will resume from where they left off. If the air fryer is not placed back within 1 minute, the function will end, and the air fryer will return to the home screen of the corresponding recipe.

CAUTIONS: 1. When keep-warm is on and the cooking temperature is set to $\geq 80^{\circ}\text{C}$, the air fryer will transition to the keep-warm mode after the cooking is completed. Otherwise, the air fryer will skip the keep-warm stage and directly display the cooking completion screen.
2. The keep-warm function is not supported in yogurt, vegetables, dried fruit, and defrost modes.

6. Pause/cancel cooking

- When the air fryer is in cooking mode, press the control knob to pause cooking. When the air fryer is cooking or paused, press and hold the control knob for 1 second to enter the canceling cooking screen. Select Yes to cancel cooking and enter the manual mode screen.

CAUTION: During cooking, the control knob can be turned to adjust the temperature and time parameters. The corresponding numbers will blink during adjustment. Once the adjustment is completed, press the control knob to confirm the new parameters.

7. Cloud recipe mode

- When a cloud recipe is selected and executed using the Mi Home/Xiaomi Home app, the air fryer will cook automatically according to the recipe. After cooking, the air fryer will enter the manual mode screen.

Notes: 1. The schedule function is available when executing cloud recipes.

2. Cloud recipes cannot be executed under the following circumstances:

- ① The air fryer or its display is turned off.
- ② There is no Wi-Fi connection.
- ③ The air fryer is in the cooking/schedule/keep-warm mode.
- ④ The air fryer's basket has been pulled out.

8. Error message

- When the air fryer detects an error, the display will show "E1" or "E2", and the air fryer will emit three brief beeps.

Cleaning & Maintenance

Unplug the power cord before cleaning and maintaining the air fryer, and wait for it to cool down to a safe temperature before proceeding. Please remove the basket from the air fryer when cleaning the air fryer.

- Surface of the air fryer:

The surface of the air fryer can be wiped with a dry, soft cloth or a sponge moistened with a neutral cleaning detergent.

- Cavity:

To remove stains from the inside of the air fryer, apply a suitable amount of detergent diluted in hot water to its surface and let it sit for about 10 minutes, then use a soft sponge moistened with water to wipe away the detergent residue.

- Basket:

Clean the air fryer after each use. The basket of the air fryer is coated, so do not use any steel wool or other abrasive cleaning materials to clean it as they may damage the coating.

- Frying plate and grill:

Use a soft, cotton cloth or sponge moistened with neutral detergent to wipe it clean, then moisten it with water to wipe away the detergent residue.

Note: The frying plate and grill can be separated and placed in the dishwasher for cleaning; the basket can be washed in water, but cannot be cleaned in the dishwasher; however, the air fryer can neither be washed in water nor be cleaned in the dishwasher.

Cleaning Precautions

1. After using the air fryer, please unplug the power plug in time. Do not place the air fryer near a source of fire and do not immerse it in water. Do not place the power plug directly on the air fryer to prevent the plug from scratching its surface.
2. Cleaning and maintenance should only be done after the air fryer has cooled down.
3. Do not use any corrosive or abrasive cleaning materials or detergents.

Note: Regular cleaning and maintenance of the air fryer will help to extend its service life.

Maintenance Tips

- Only professionally trained and qualified technicians should repair the air fryer.
- Others should not repair the air fryer without permission to avoid serious consequences.
- When the air fryer malfunctions, please refer to Troubleshooting before contacting the after-sales service team.
- If the issue persists, please unplug the power cord to disconnect it and contact the after-sales service team.

Troubleshooting

Issue	Possible Causes	Solutions
The air fryer doesn't function.	The air fryer is not connected to a power supply.	Plug the power cord into a grounded electrical outlet.
	The basket is not pushed into place.	Pull out the basket and push it back into place.
Display shows E1.	The sensor has a broken circuit.	Contact the after-sales service team.
Display shows E2.	The sensor has a short circuit.	Contact the after-sales service team.
The fan doesn't rotate.	The fan blade is stuck.	Contact the after-sales service team.
	The motor is damaged or other components have a broken circuit.	Contact the after-sales service team.
White smoke is coming out.	Cooking oily ingredients.	When you fry ingredients containing more fat, there will be a lot of smoke, which is normal.
	The air fryer still contains grease residue from the previous cooking program.	Ensure that you clean the air fryer after each cooking program.
Can't insert the basket into the air fryer smoothly.	Too many ingredients in the basket.	The ingredients in the basket can't exceed the maximum mark.
	The basket is not properly inserted.	Properly insert the basket.
The schedule function doesn't function as requested.	The scheduled time is too short.	The scheduled time should be longer than the cooking time.
	The scheduled time is not saved.	The scheduled time should be saved and carried out by pressing the control knob.
Wi-Fi can't be connected.	The Mi Home/Xiaomi Home app is not the latest version.	Update the Mi Home/Xiaomi Home app to the latest version.
	The Wi-Fi signal is weak.	Move to a location where the signal is strong enough.
Unable to connect the air fryer.	Wi-Fi cannot be connected.	Check whether the Wi-Fi is connected normally or reset the Wi-Fi to reconnect.

Electrical Diagram

- ① LCD Display
- ② Thermostat Probe
- ③ Control Panel
- ④ Dual-Speed Motor
- ⑤ Fuse
- ⑥ Heating Element
- ⑦ Power Board
- ⑧ Fuse
- ⑨ Micro Switch

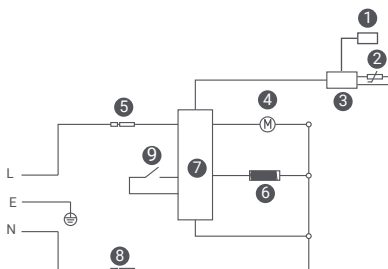

Specifications

Name: Oven (Air Fryer)	Capacity: 4.5 L	Color: White
Model: MAF14	Rated Frequency: 50–60 Hz	Net Weight: 4.0 kg
Rated Power: 1500 W	Rated Voltage: 220–240 V~	Gross Weight: 4.7 kg
Maximum Output Power of the Wi-Fi Module: < 20 dBm		Operating Frequency: 2412–2472 MHz
Operating Temperature: -10°C to 40°C Package Dimensions: 370 × 295 × 340 mm		
Wireless Connectivity: Wi-Fi IEEE 802.11 b/g/n 2.4 GHz		

Under normal use of condition, this equipment should be kept a separation distance of at least 20 cm between the antenna and the body of the user.

CE Hereby, Ningbo Careline Electric Appliance Co., Ltd. declares that the radio equipment type Oven (Air Fryer) MAF14 is in compliance with Directive 2014/53/EU. The full text of the EU declaration of conformity is available at the following internet address: <http://www.mi.com/global/service/support/declaration.html>



All products bearing this symbol are waste electrical and electronic equipment (WEEE as in directive 2012/19/EU) which should not be mixed with unsorted household waste. Instead, you should protect human health and the environment by handing over your waste equipment to a designated collection point for the recycling of waste electrical and electronic equipment, appointed by the government or local authorities. Correct disposal and recycling will help prevent potential negative consequences to the environment and human health. Please contact the installer or local authorities for more information about the location as well as terms and conditions of such collection points.

Manufactured for: Xiaomi Communications Co., Ltd.
 Manufactured by: Ningbo Careline Electric Appliance Co., Ltd.
 (a Mi Ecosystem company)

Address: No.558, Wei'er Road, Andong Industrial Zone,
 Hangzhou Bay New Area, Ningbo, 315327, Zhejiang, China
 For further information, please go to www.mi.com

User Manual Version: V1.0

Importer:
 Beryko s.r.o.
 Pod Vinicemi 931/2, 301 00 Plzeň
www.beryko.cz